

▪ ZADATAK 1

Prema priloženoj listi aktivnosti napravite mrežni plan, gantogram i histogram! Ažurirajte gantogram i histogram!

RB	Opis Aktivnosti	Ta	PA	UA	Radnici
1	aktivnost A	3	--	B	2
2	aktivnost B	1	--	A	3
3	aktivnost C	4	A ST(2)	D	4
4	aktivnost D	2	A, B	C	3
5	aktivnost E	5	C, D NT(5)	--	5
6	aktivnost F	4	E ST(2)	G, H	5
7	aktivnost G	6	E	F, H	8
8	aktivnost H	4	E	F, G	5
9	aktivnost I	3	G ST(3), H	--	5
10	aktivnost J	2	F, I	--	4

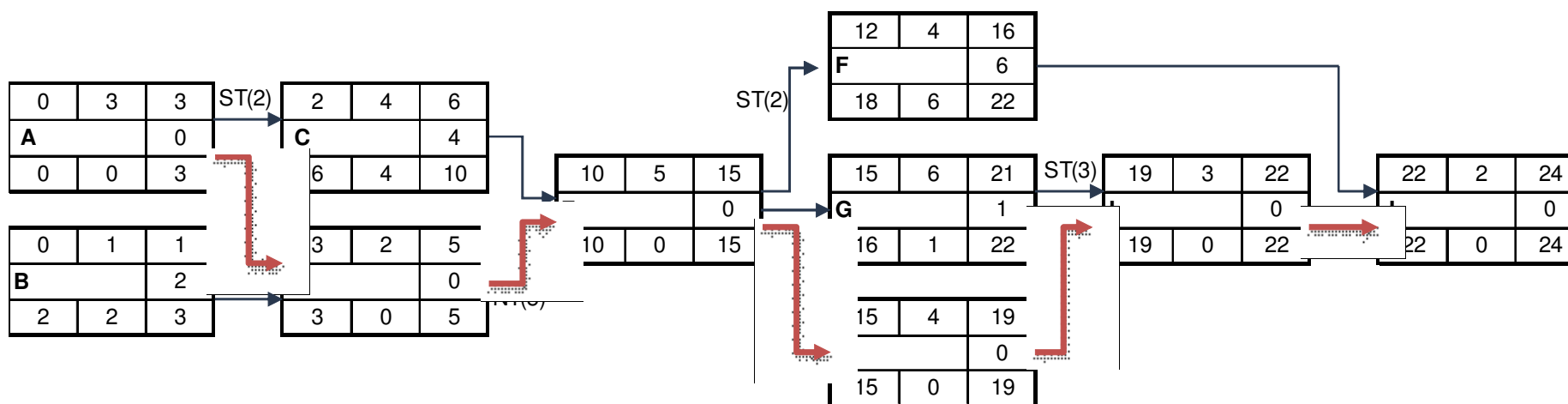

KRITIČNI PUT: A-D-E-H-I-J



Gantogram

RB	AKTIVNOST	Ta	1	2	3	4	5	6	7	8	9	10	11	12	13	14	15	16	17	18	19	20	21	22	23	24	25
1	A	3	█	█	█																						
2	B	1	█	R	R																						
3	C	4			█	█	█	█	R	R	R	R															
4	D	2				█	█																				
5	E	5											█	█	█	█	█										
6	F	4												█	█	█	█		R	R	R	R	R	R			
7	G	6																█	█	█	█	█	█		R		
8	H	4																█	█	█	█						
9	I	3																				█	█	█			
10	J	2																							█	█	

Histogram

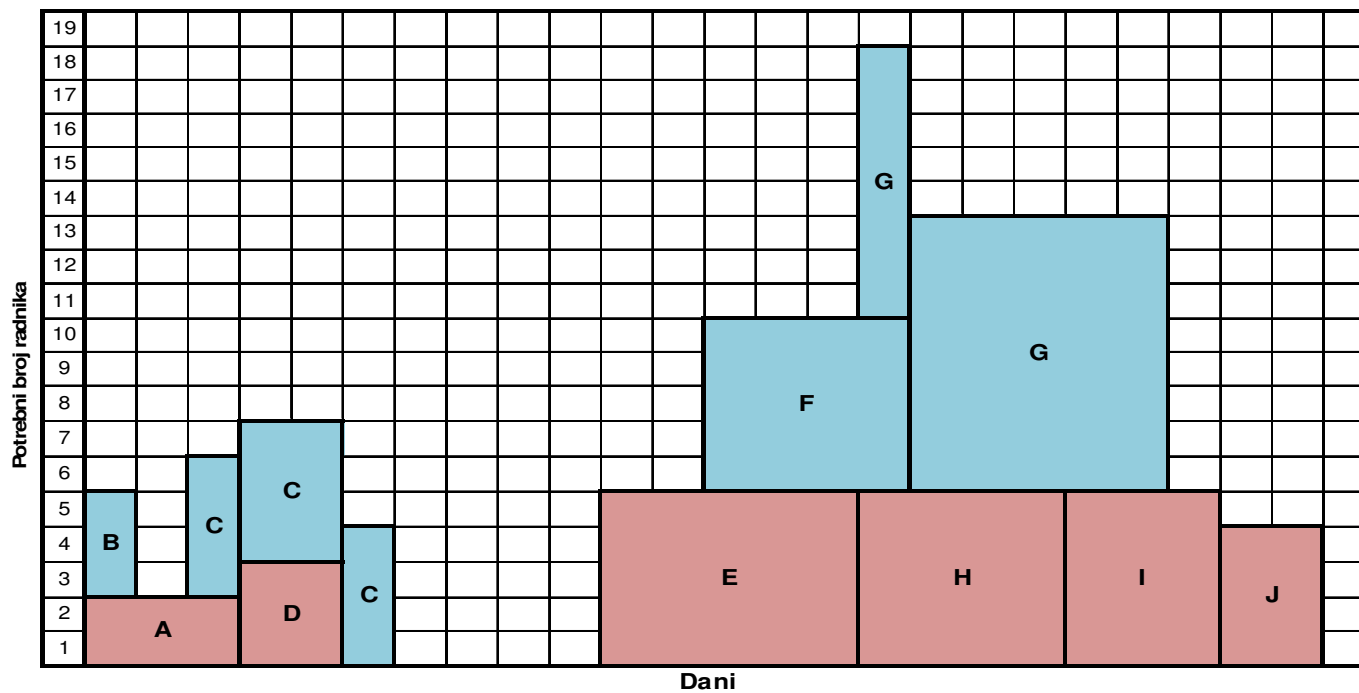



Ažurirani gantogram

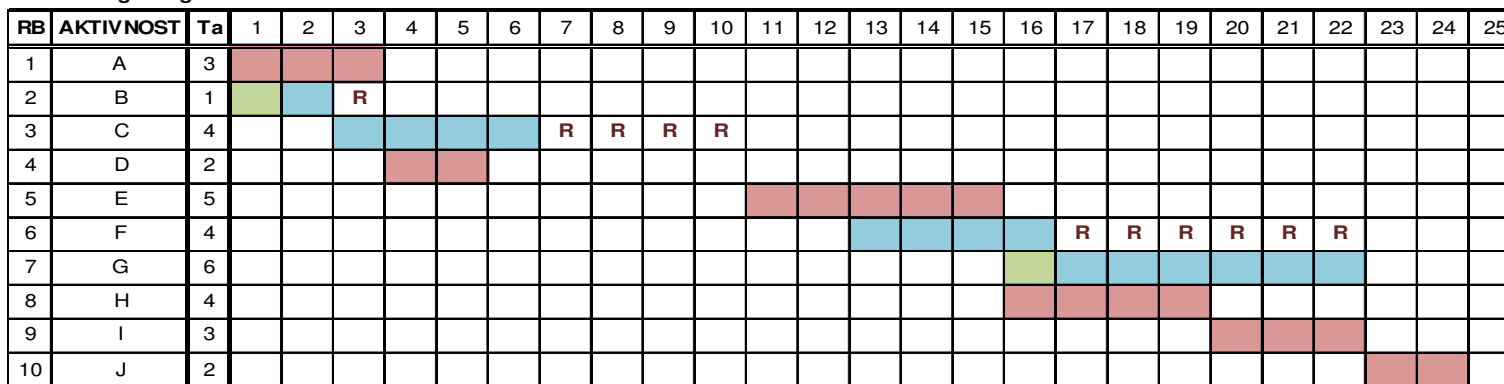

Ažurirani histogram

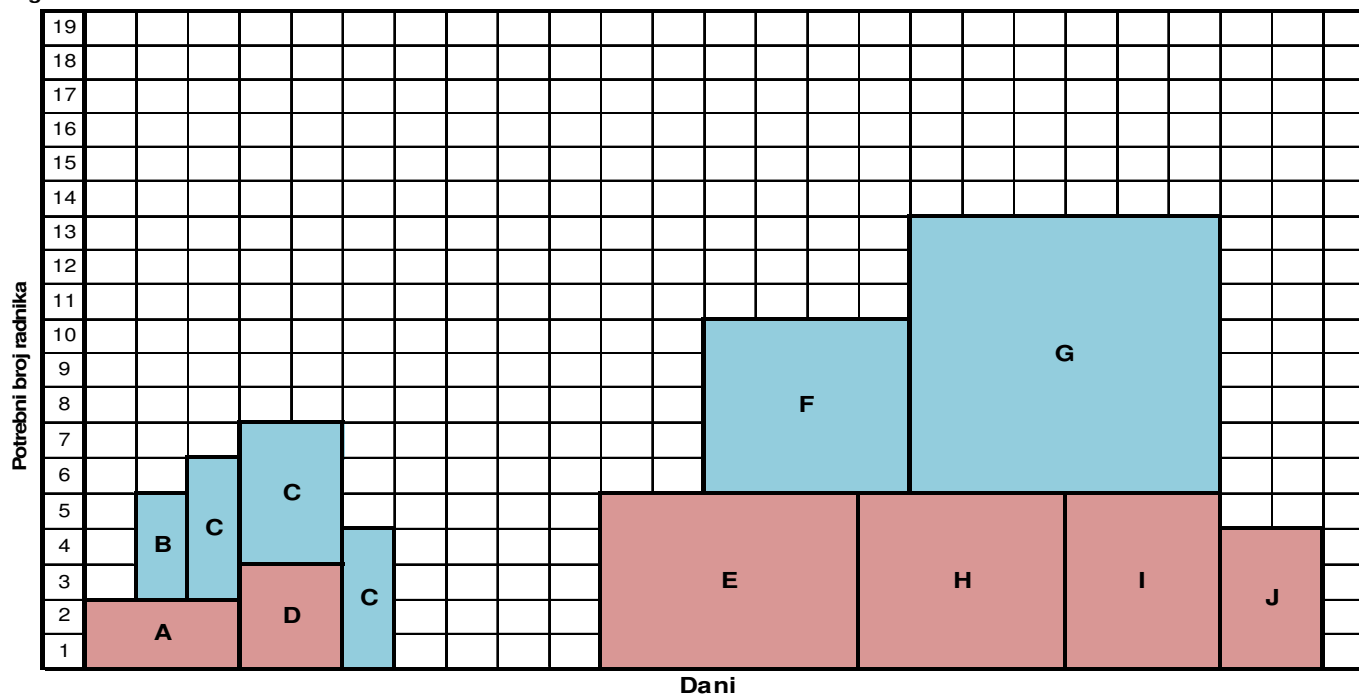

▪ ZADATAK 2

Prema priloženoj listi aktivnosti napravite mrežni plan, gantogram i histogram! Ažurirajte gantogram i histogram!

RB	Opis Aktivnosti	Ta	PA	UA	Radnici
1	aktivnost A	4	--	--	2
2	aktivnost B	3	A FT(2)	--	3
3	aktivnost C	7	B	D, E, F	4
4	aktivnost D	9	B	C, E, F	3
5	aktivnost E	14	B	C, D, F	5
6	aktivnost F	12	B	C, D, E	5
7	aktivnost G	5	D	H	8
8	aktivnost H	6	EST(18) F NT(5)	G	5
9	aktivnost I	7	C	J	1
10	aktivnost J	11	G	I	4
11	aktivnost K	9	H, I NT(9), J	--	6

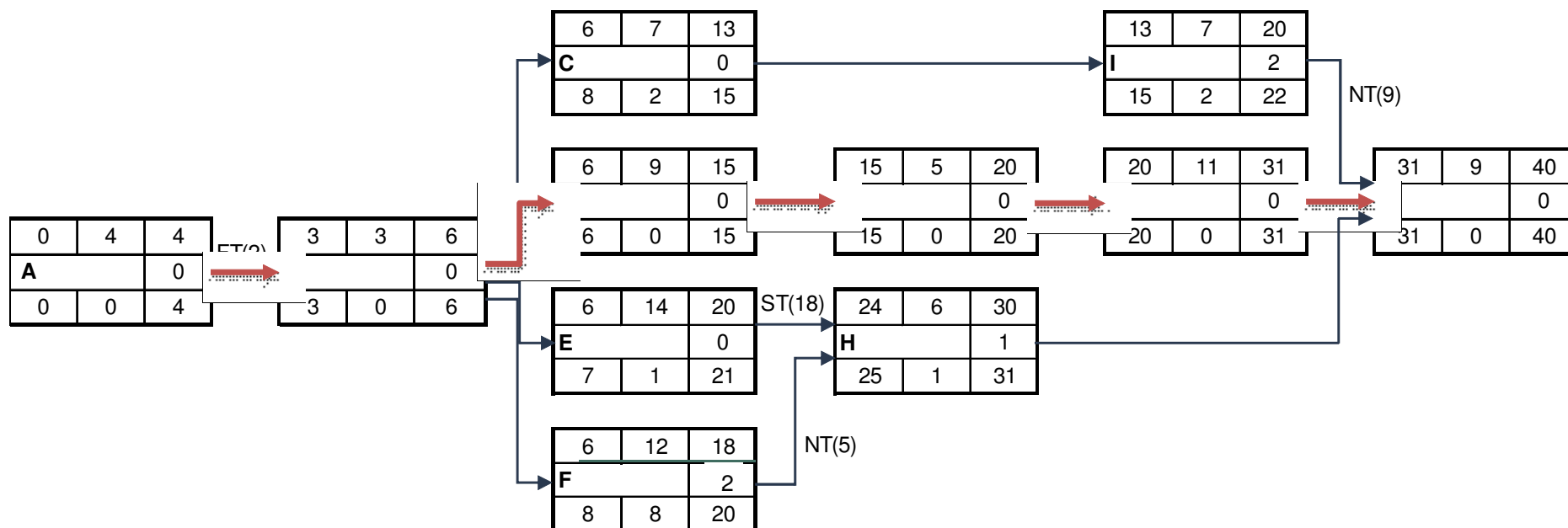

KRITIČNI PUT: A-B-D-G-J-K



Gantogram

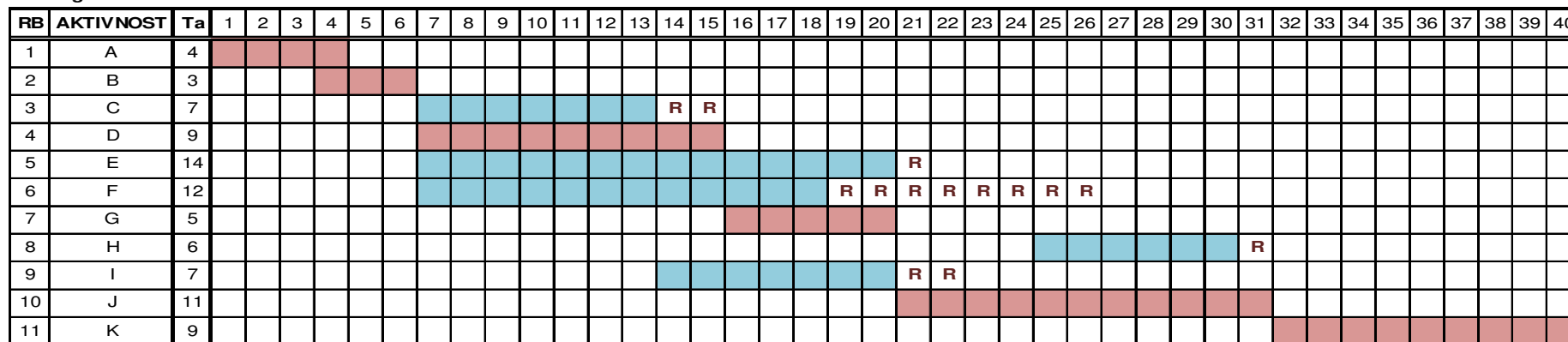

Histogram

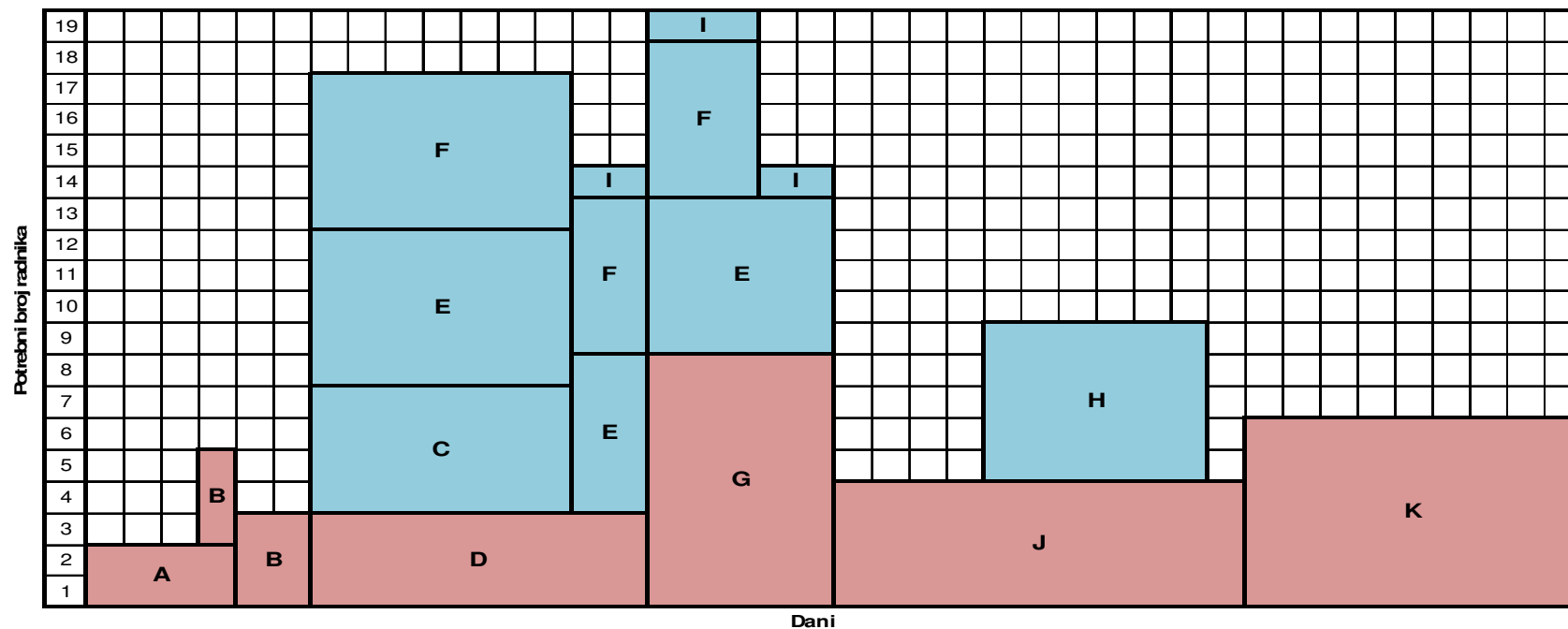



Ažurirani gantogram

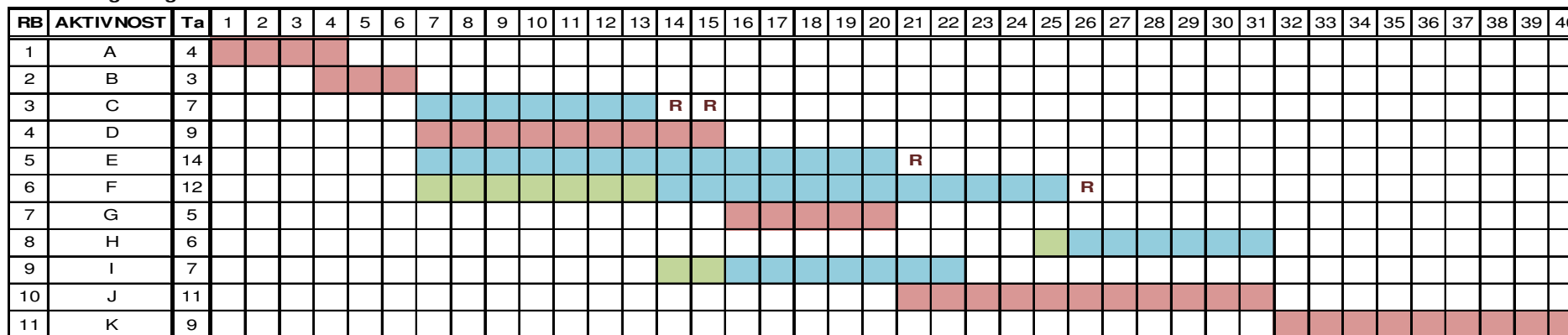

Ažurirani histogram

